

Senior General Than Shwe congratulates Mr Hu Jintao

NAY PYI TAW, 27 Oct— Senior General Than Shwe, Chairman of the State Peace and Development Council of the Union of Myanmar, has sent a message of congratulations to His Excellency Mr Hu Jintao, President of the People's Republic of China, on his re-election as the General Secretary of the Central Committee of the Communist Party of China at the 17th Congress of the Communist Party of China on 22 October, 2007. —MNA

Senior General Than Shwe felicitates Turkmenistan President

NAY PYI TAW, 27 Oct— Senior General Than Shwe, Chairman of the State Peace and Development Council of the Union of Myanmar, has sent a message of felicitations to His Excellency Mr Gurbanguly Berdimuhamedow, President of the Republic of Turkmenistan, on the occasion of the Independence Day of the Republic of Turkmenistan which falls on 27 October, 2007. —MNA

Prime Minister Lt-Gen Thein Sein sends felicitations to Turkmenistan

NAY PYI TAW, 27 Oct— Lt-Gen Thein Sein, Prime Minister of the Union of Myanmar, has sent a message of felicitations to His Excellency Mr Gurbanguly Berdimuhamedow, Prime Minister of the Republic of Turkmenistan, on the occasion of the Independence Day of the Republic of Turkmenistan which falls on 27 October, 2007. —MNA

Four political objectives

- * Stability of the State, community peace and tranquillity, prevalence of law and order
- * National reconsolidation
- * Emergence of a new enduring State Constitution
- * Building of a new modern developed nation in accord with the new State Constitution

Four economic objectives

- * Development of agriculture as the base and all-round development of other sectors of the economy as well
- * Proper evolution of the market-oriented economic system
- * Development of the economy inviting participation in terms of technical know-how and investments from sources inside the country and abroad
- * The initiative to shape the national economy must be kept in the hands of the State and the national peoples

Four social objectives

- * Uplift of the morale and morality of the entire nation
- * Uplift of national prestige and integrity and preservation and safeguarding of cultural heritage and national character
- * Uplift of dynamism of patriotic spirit
- * Uplift of health, fitness and education standards of the entire nation

Abhidhamma Day ceremonies held at famous pagodas, stupas in Yangon

YANGON, 26 Oct — Theravada Buddhist Myanmar people today held the lighting festivals dedicated to paying homage to the Lord Buddha who expounded Abhidhamma discourse on Fullmoon Day of Thadingyut.

The people also performed meritorious deeds at pagodas, monasteries and religious buildings.

At Shwedagon Pagoda, the 'soon' offering ceremony was held this morning. Members of the pagoda board of trustees, members of religious associations and service personnel offered 'soon' to the pagoda. State Ovadaçariya and Ovadaçariya of the pagoda board of trustees Maha Aungmyebonsan Monastery Sayadaw Agga Maha Pandita Abhidhaja Maha Rattha Guru Abhidhaja Agga Maha Saddhammajotika Bhaddanta Paññindabhivamsa administered the Nine Precepts. Officials donated alms to the Sayadaw.

Organized by Sule Pagoda Board of Trustees, the 5,000 lights and fruit offering ceremony was held at the pagoda this morning. In the afternoon, employees of the pagoda board of trustees recited Abhidhamma Desana.

At Botahtaung Pagoda in Botahtaung Township, members of the Sangha administered Desana to
(See page 8)



The Shwedagon Pagoda being packed with devotees of Buddhism on Fullmoon Day of Thadingyut, 26 October.—NLM

Emergence of the State Constitution is the duty of all citizens of Myanmar Naing-Ngan.

PERSPECTIVES

Saturday, 27 October, 2007

Work together under UN coordination to overcome global challenges

In this age of globalization, countries have become more interconnected and thus collective efforts for peace, security and development under the leadership of the United Nations are of vital importance.

The United Nations was founded on 24 October 1945. And it is now 62 years. During its term, the United Nations Member States have been striving together with other organizations and progress has been made step by step in handling immediate problems. But continued efforts are to be made in preventing conflict, building and maintaining peace, disarmament and nonproliferation of arms.

In the Millennium Development Goals, United Nations Member States have pledged to eradicate extreme poverty and hunger, to achieve universal primary education, to promote gender equality and empower women, to reduce child mortality, to improve maternal health, to combat HIV/AIDS, malaria and other diseases, to ensure environmental sustainability and to develop a global partnership for development.

Of the Millennium Development Goals, to ensure environmental sustainability is of utmost importance now as climate change is no longer a mere environmental problem but becoming a threat to global security.

With increasingly unstable climate resources are already stretched to the limit, and this will have a great impact on environmental issue and development.

Global problems are largely concerned with all nations of the world. To overcome these global challenges all United Nations Member States should divert from regional or bilateral squabbles and unitedly contribute and work together under the United Nations coordination.

နိုင်ငံတော်အစိုးရဌာနပိုင် မော်တော်ယာဉ်မသုံးစွဲရနေ

လစဉ် လ၏ ဒုတိယပတ် (တနင်္ဂနွေနေ့) နှင့် နောက်ဆုံးပတ် (တနင်္ဂနွေနေ့) တို့သည် ရုံးလုပ်ငန်းအတွက် မဖြစ်မနေသွားလာရန် လိုအပ်သည့်ကိစ္စရပ်များမှအပ မော်တော်ယာဉ်များ မသုံးစွဲရနေဖြစ်သည်။

၂၀၀၇-ခုနှစ် အောက်တိုဘာလ အတွက်

နောက်ဆုံးပတ် (တနင်္ဂနွေနေ့)
(၂၈-၁၀-၂၀၀၇) ရက်နေ့

၂၀၀၇-ခုနှစ် နိုဝင်ဘာလ အတွက်

(၁၁-၁၁-၂၀၀၇) ရက်နေ့
နှင့်
(၂၅-၁၁-၂၀၀၇) ရက်နေ့

People's Desire

- * Oppose those relying on external elements, acting as stooges, holding negative views
- * Oppose those trying to jeopardize stability of the State and progress of the nation
- * Oppose foreign nations interfering in internal affairs of the State
- * Crush all internal and external destructive elements as the common enemy

Htidaw (Umbrella) hoisted atop pagoda in Pantapwint Taung Region



A wellwisher donates K 5 million to the funds of Pantapwint Taung Sasana Region through Sayadaw Bhaddanta Paññasara.

YANGON, 26 Oct — A ceremony to hoist Htidaw (Umbrella) atop Koetaungpyi Pagoda at Pantapwint Taung Sasana Region was held in Taikkyi Township, Yangon North District today.

Pantapwint Taung Sayadaw Saddhammajotikadhaja Bhaddanta Paññasara and donor U Zar Ni Tun- Daw Theingi Myint family hoisted the Htidaw (umbrella) atop Koetaungpyi Pagoda.

After that, 18 wellwishers offered requisites for reordination ceremony to the Sayadaw.

Later, Minister for Construction Maj-Gen Saw Tun-Daw Myint Myint Ko family and other donors made cash donation to the Sayadaw.

In the evening, the wellwishers offered lights to the pagodas in the Pantapwint Taung Sasana Region.

MNA

Myanmar delegation to attend China-ASEAN Trade Fairs

YANGON, 26 Oct — The 18 members of Myanmar delegation headed by Chairman of Myanmar Industrialists Association U Paw Hein and Secretary Dr Pwint San left here by air for the People's Republic of China this morning.

The Myanmar delegation will attend the 4th China-ASEAN Business and Investment Summit, and China-ASEAN Trade Fairs to be held from 28 to 31

Delegation of Myanmar Industrialists Association seen at Yangon International Airport before departure for China. UMFCCI



Foreign Minister sends felicitations to Turkmenistan

NAY PYI TAW, 27 Oct — U Nyan Win, Minister for Foreign Affairs of the Union of Myanmar, has sent a message of felicitations to His Excellency Mr Rashit Meredow, Minister of Foreign Affairs of the Republic of Turkmenistan, on the occasion of the Independence Day of the Republic of Turkmenistan which falls on 27 October, 2007. — MNA

Sports gear presented to Central Command Hockey Team



Managing Director U Zaw Win (Just Fashion) presents hockey equipment to Chairman of Central Command Hockey Sport Supporting Committee Brig-Gen Hla Win. — MHF

YANGON, 25 Oct — Just Fashion of Yuzana Plaza in Yangon donated hockey equipment to the Central Command Hockey Team at Mandalay on 22 October.

Managing Director U Zaw Win of the fashion shop presented the equipment to Brig-Gen Hla Win of the command.

Afterwards, Vice-President of Myanmar Hockey Federation U Kyaw Naing explained facts about the donation. Brig-Gen Hla Win expressed thanks for the donation.

The Central Command Hockey Team will take part in the 11th Defence Services Commander-in-Chief's Shield Tatmadaw (Army, Navy, Air) Hockey Tournament for 2007 to be held from 20 to 29 December in Pathein. — MNA

INTERNATIONAL NEWS

Protester waves blood-coloured hands in Rice's face

WASHINGTON, 26 Oct — An anti-war protester waved blood-coloured hands in US Secretary of State Condoleezza Rice's face at a congressional hearing on Wednesday and shouted "war criminal!", but was pushed away and detained by police.

Rice, an architect of President George W Bush's Iraq policy, appeared unfazed by the incident, which occurred when she entered a House of Representatives meeting room to testify at a hearing on US Middle East policy.

"Out!," shouted the chairman of the Foreign

Relations committee, Representative Tom Lantos, as police moved in to hustle the woman protester away.

Lantos, a California Democrat, also demanded the removal of several other demonstrators from the Code Pink organization, an anti-war

group that often disrupts hearings on Capitol Hill.

"What are you doing, what are you doing?" the protesters screamed as police dragged them away.

Capitol Police said later three people were arrested and charged with disruption of Congress.

MNA/Reuters

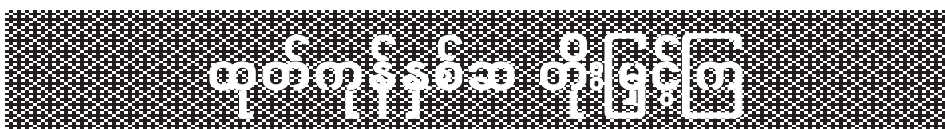

In this photo released by the Florida Keys News Bureau, Ken Smith of Sebring, Fla, carves his top prize-winning entry in the Underwater Pumpkin Carving Contest on 20 Oct, 2007, off Key Largo, Fla, in the Florida Keys National Marine Sanctuary.

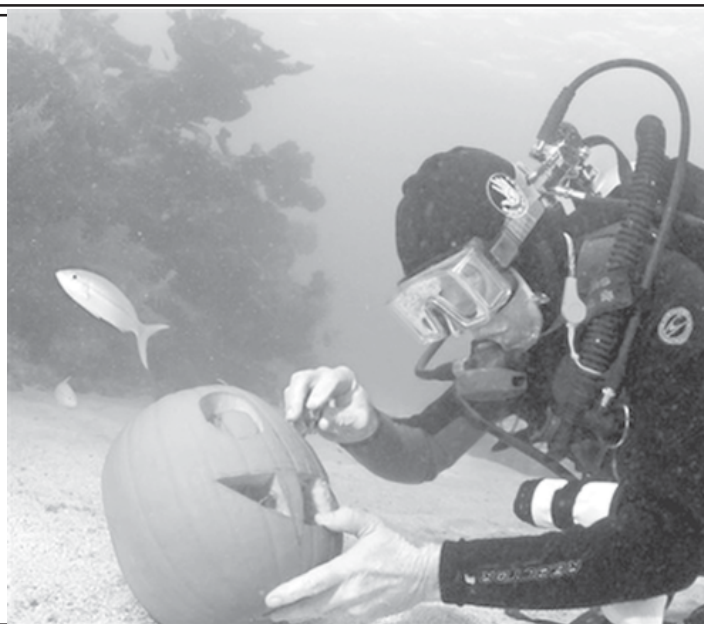

UNHCR says 28 killed, 38 missing off Yemeni coast

GENEVA, 25 Oct— Up to 66 people drowned in the Gulf of Yemen while trying to cross from Somalia to Yemen at the weekend, the United Nations refugee agency said on Tuesday.

Ron Redmond, spokesman for the UN High Commissioner for Refugees (UNHCR), said some passengers crowded into smugglers' boats

were subject to beatings, and many were forced overboard and into deep water off the Yemeni coast.

Of the group of 244 would-be migrants—mainly from Somalia and Ethiopia—Redmond said 28 had been confirmed drowned and 38 others were still missing after the Saturday-Sunday voyage.

The total number of

refugees seeking to go to Yemen, seen as a gateway to the Middle East, has been steady compared with 2006, although more people have died this year.

In 2006 the UNHCR recorded 330 fatalities from the voyage, with 300 missing and believed dead, while this year at least 439 people have died, with another 489 missing and feared dead.

"More people are getting into fewer boats," Redmond told journalists, when asked why the death rate had risen.

He said the desperation of many Somalis and Ethiopians, as well as would-be migrants from Kenya, Uganda and Tanzania, made them willing to risk their lives in the Gulf of Aden journey despite the dangers involved.

At the same time, Redmond said smugglers were treating their passengers with increasing disdain. —MNA/Reuters

A view of Europe's global navigation satellite system Galileo on display in the workshop of the Baikonur cosmodrome in 2005. The EU's troubled Galileo satellite navigation network, meant to rival the US Global Positioning System (GPS), needs millions more euros next year than planned, European MPs warned Thursday.— INTERNET

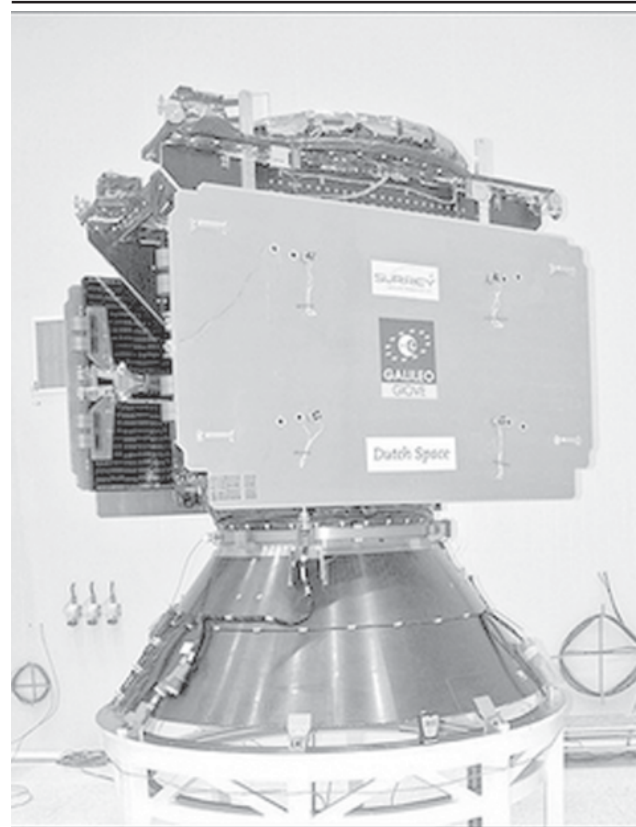

US nuke sub fails to carry out daily checks

WASHINGTON, 25 Oct— Another security lapse concerning the US military's handling of nuclear weapons emerged Monday, with news that the crew of a nuclear submarine failed to carry out daily reactor safety checks for a month.

The crew also forged

records to cover up their mistakes, agencies reported. The revelation followed the incident in which a B-52 bomber was accidentally loaded with nuclear missiles and flown across the country without any one realizing it was carrying the weapons.

In the case of the USS

Hampton nuclear submarine, officials discovered that sailors had not done the required analysis of the chemical and radiological properties of the submarine's reactor for more than a month, even though a daily check is required.

MNA/Xinhua

Few shoppers can be seen at the reopened Glorietta shopping mall as one of its sections, the Glorietta 2, remains closed on 25 Oct, 2007, at the financial district of Makati city east of Manila, Philippines, following Friday's explosion that killed 11 people and wounded more than a hundred others.



INTERNET

Iraqi police kill two infants in Kerbala raid

BAGHDAD, 25 Oct—Iraqi police searching for a member of Shiite cleric Moqtada al-Sadr's militia, shot dead his two infant daughters and wounded his wife in a raid on Tuesday, a senior official in Sadr's movement said.

Haider Mujed was away when a police unit raided his house in Kerbala, Haider al-Jaberi told Reuters. The police then shot his two daughters, Mariam, three, and Ayat, 18 months, he added.

The police in the city said a shooting has occurred and that Mujed's wife and one daughter were wounded, but did not give further details.

"They killed his children deliberately, they shot them," Jaberi said. "Nothing justifies what happened. They have killed infants."

A source in a hospital in Kerbala said it had received the bodies of two female children and two wounded women.

MNA/Reuters

First superjumbo "A380" launches inaugural S'pore flight



A security official checks the passports of passengers at the gate before the Airbus A380 superjumbo took off from Singapore's Changi Airport on 25 Oct, 2007. — INTERNET

SINGAPORE, 25 Oct— The world's first superjumbo A380 bought by Singapore Airlines (SIA) launched its inaugural commercial flight from Singapore to Sydney of Australia, on

Thursday. The SIA A380 departed the Singapore's Changi Airport at 08:16 am local time (0016 GMT), carrying more than 400 passengers. This Flight SQ380 is

expected to arrive at Sydney almost seven and a half hours later and will return to Singapore the following day.

William Leong, a timekeeper businessman, paid 7080 US dollars to bid eight tickets for his father and siblings.

"I promised my 90-year-old father to bring him to fly the first SIA A380 flight three years ago when I knew this event," he told *Xinhua* before boarding. His father Leong Loutech, the oldest passenger on board, sat in wheelchair kept silence and smiling.

The youngest passenger, a 10-month-old boy, slept deeply in his

mother's arms, regardless of photographers lens and flashes. His father Quek Kai Soon told reporters, "I wish the baby and his two sisters will remember this historic experience."

Singapore Airlines has installed 471 seats to offer more space, particularly in business and first class. SIA's version has a "suites" class of 12 compartments with full-size bed, 60 business seats and 399 economy seats.

On the first flight, two top chefs, one from Singapore and another from Sydney, will on board in charge of a champagne brunch for all the passengers.

MNA/Xinhua

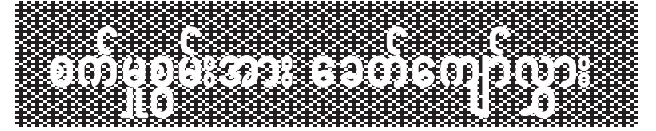

Russia's President Vladimir Putin looks at the Hermitage collection of the Russian Empire at the Ajuda palace in Lisbon on 25 Oct, 2007.

INTERNET

The opening ceremony of the 6th Chinese City Games is held in Wuhan, capital of central China's Hubei Province, on 25 Oct, 2007.

XINHUA



American tourist killed by train in S Africa

JOHANNESBURG, 25 Oct— An American tourist died on Tuesday after being struck by a train at St James railway station near Muizenberg, Cape Town, Western Cape police spokesman Captain Elliot Sinyangana said the train hit the man while he was taking photographs at 2 pm.

His next of kin had not yet been informed, he said. However, the report by South African Press Association did not reveal the identity of the American tourist. — MNA/Xinhua

7.0 magnitude earthquake hits S-W Sumatra

BEIJING, 25 Oct — An earthquake measuring 7.0 degrees on the Richter Scale jolted seas southwestern of Sumatra, Indonesia, at 5:02 am Beijing Time Thursday.

The epicentre was located at 3.9 degrees south Latitude and 100.9 degrees east Longitude, according to China's earthquake monitoring network. The epicentre is about 110 kilometres away from the nearest coastline and 180 kilometres from Indonesia's largest city of Bengkulu.

MNA/Xinhua

NATO soldier dies, two others sustain injuries in E Afghanistan

KABUL, 25 Oct — A soldier of NATO-led International Security Assistance Force (ISAF) has been killed and two others wounded during a firefight with insurgent in eastern Afghan province of Kunar, said an ISAF statement issued late Tuesday.

The statement did not disclose the casualty's nationality. It added that there were no reports of civilian casualties in the operation.

Currently a 55,000 strong international troops including ISAF are in war-torn Afghanistan for securing peace and assisting in reconstruction.

MNA/Xinhua

US general outlines Baghdad security handover plan

BAGHDAD, 25 Oct — US forces hope to hand over half of Baghdad to Iraqi security forces by the end of 2008, after violence in Iraq dropped to its lowest level since January 2006, the No 2 US general in Iraq said on Wednesday.

"We are anxious for them to take over full responsibility as they are anxious to take full responsibility," Lieutenant-General Raymond Odierno, in charge of US forces' day-to-day operations in Iraq, told a Baghdad news conference.

"You will see steady progress over the next 12 months of us turning large

portions of Baghdad (over) to Iraqi security forces as we continue to have success. I think it will be somewhere between 40 and 50 percent by the end

of the year."

His comments are significant because stabilising the capital, torn apart by sectarian violence, was the main

goal of a 30,000-US troop build-up that began in February, part of a plan to give feuding political leaders time to reconcile.

MNA/Reuters

Sarkozy's approval rating declines further

PARIS, 25 Oct — The approval rating for French President Nicolas Sarkozy has declined further by two percentage points, according to the findings of latest opinion poll published Wednesday by the French magazine *l'Express*.

According to the poll which was conducted by the Paris-based research company BVA, the popularity of the head of

state has fallen from 57 per cent in September to 55 per cent this month.

The number of people who do not approve of the President has increased from 33 per cent to 37 per cent during the same period, according to the same source.

In addition, the poll showed the approval rating for Prime Minister Francois Fillon also falling by two percentage points,

declining from 45 per cent in September to 43 per cent in October.

According to the poll, the number of people disapproving of the Prime Minister has increased by 7 percentage points, moving from 34 per cent last month to 41 per cent this month, with 16 per cent of the respondents declining to give their opinion on the matter.

MNA/Xinhua

ECONOMIC NEWS

Saudi Arabia bans “Forbes” issue over king’s wealth report

RIYADH, 25 Oct— Saudi Arabia has banned the latest issue of the Arabic-language edition of *Forbes* magazine for an article about the wealth of the king and other Arab leaders, its managing editor said on Wednesday.

“The reason was a two-page report on the wealth of 15 ruling dynasties, seven of which are Arab,” Refaat Jaafar, managing

editor of Dubai-based *Forbes Arabia*, told *Reuters*.

“This sort of ban is counterproductive.” He said the Saudi distribution company was told about the ban on Tuesday.

“Instead of ripping out the pages of the report, the authorities decided to ban the magazine altogether,” said one government official, speaking on

condition of anonymity.

Officials at the Information Ministry could not immediately comment on the ban.

The report ranked King Abdullah third, behind the rulers of Brunei and the United Arab Emirates.

MNA/Reuters



The 16th Golden Rooster and Hundred Flowers Film Festival opened with film stars singing and dancing on the stage in Suzhou, on 24 Oct, 2007.

INTERNET

Malaysia’s auto sales up 4.9% in September

KUALA LUMPUR, 25 Oct — Malaysia’s automotive vehicle sales reported at 44,984 units in September this year, up 4.9 percent compared with the same month last year.

According to the Malaysian Automotive Association on Wednesday, sales of passenger cars rose to 40,892 units in the month, while 38,818 units were sold in the same month last year.

Sales of commercial vehicles improved to 4,092 units in September this year from 4,066 units in the same month last year. Total sales of vehicles for the first nine months of this year in the country amounted to 358,234 units, dropping from 382,403 units in the same period of last year.

On the production front, a total of 40,660 automotive vehicles were produced in September

this year in the country, up from 39, 874 units in the same month last year, the association said.

The production of passenger cars rose to

37,356 units from 35, 600 units, while that of commercial vehicles dropped to 3,304 units from 4,274 units.

The country produced

a total of 327,340 vehicles in the first nine months of this year, dropping from 400,024 units in the same period of last year.

MNA/Xinhua

IEA says nuclear power output could double by 2030

VIENNA, 25 Oct— The world’s output of nuclear power could nearly double by 2030, fuelled by demand from energy-hungry emerging economies and fears about security of supply and climate change, the UN said on Wednesday.

But the share that nuclear energy will contribute to global electricity production is still set to decline over the same period, the International Atomic Energy Agency (IAEA) said in its latest annual projection of growth of nuclear power.

Much of the expansion

in nuclear-generated electricity will be in the far east and south Asia, IAEA nuclear energy analyst Alan McDonald said in an online interview.

“China and India have

booming economies, booming populations and growing energy demand,” he said. “They basically need to develop all the energy sources they can.”

MNA/Reuters

More Japanese industries raise CO2 emission cut targets

TOKYO, 25 Oct — Japanese trucking firms, home builders, instant noodle makers and sugar manufacturers promised to take additional measures to help reduce greenhouse gas emissions

and help the country meet climate change goals, the government said.

The announcement follows similar moves to raise reduction targets announced by 17 industries, including chemical makers, paper makers and oil refiners, for additional cuts of a total of 15.5 million tons a year of carbon dioxide (CO2) equivalent.

The new goals by the four industries are seen helping bring the total CO2 cuts by the 21 industries to around 20 million tons or higher, enough to clear the minimum levels required under the Kyoto Protocol.

Japan is struggling to meet its target of cutting emissions from 1990 levels by 6 per cent over the 2008-2012 period.

MNA/Reuters



File photo shows a shopkeeper putting out pots of kimchi at a market in Seoul. Another time-hallowed tradition is dying out in South Korea with 65 percent of women confessing they do not know how to make kimchi, according to a survey.— INTERNET

Global air passenger number to reach 2.75b by 2011

GENEVA, 25 Oct — The global transport industry will handle 2.75 billion passengers in 2011, a rise of 29 per cent compared with the number in 2006, the International Air Transport Association (IATA) said on Wednesday.

The Geneva-based organization said the number of cross-border passengers is expected to rise from 760 million in 2006 to 980 million in 2011 at an annual average growth rate of 5.1 per cent.

Domestic passenger demand is expected to grow from 1.37 billion passengers in 2006 to 1.77 billion in 2011 at an annual growth rate of 5.3 per cent, fuelled mainly by expansion in the Indian and Chinese domestic markets. “The numbers clearly show that the world wants to fly. And it also needs to fly. Air transport is critical to the fabric of the global economy, playing a critical role in wealth generation and poverty reduction,” said Giovanni Bisignani, IATA’s director general and CEO, in a Press release. — MNA/Xinhua



A traditional Chinese embroidery masterpiece is shown on Chinese Embroidery Masterpieces Exhibit in the Royal Culture Centre in central Amman, on 24 Oct, 2007.—XINHUA

The Significant and Noble Day of Abhidhamma (The Fullmoon Day of Thadingyut, Mahapavarana Day)

Ba Sein (Religious Affairs)

The Significant and Noble Day of Abhidhamma (the Fullmoon Day of Thadingyut, Mahapavarana Day) falls on 26th October in the year 2007.

In the fourth week, after attaining the enlightenment, the Buddha began to contemplate and review the Dhamma (the truth) He had realized near the Bodhi tree. On His seventh Vassa (Seven Years) of enlightenment, the Buddha, out of compassion for the devas and brahmas, went to the Tavatimsa Devaloka (Celestial abode) where he preached the Abhidhamma Pitaka (Basket of Ultimate things) for a full three months to His deceased mother who was reborn as Santusita Deva, and also to the other devas and brahmas assembled there, hoping to make them realize the four ultimate things for which Knowledge of Abhidhamma is absolutely necessary because it deals with the highest and ultimate sense of things springing into being as facts as distinct from mere names.

After preaching Abhidhamma (Ultimate Truth) to Santusita Deva and other Devas and brahmas for a full three months, the Buddha returned to the human abode on the Fullmoon Day of Thadingyut. According to the Pali Text, three decorated stairways of silver, gold and ruby beginning from the top of the great Mount Meru to the gate of Sankassa town on earth were created as a token of paying deep homage to the Buddha who returned to the human abode. The Buddha took the middle stairway accompanied by Devas and Brahmas who took right stairway and left stairway. All Devas and Brahmas from the Tavatimsa Devaloka (Celestial abode) paid deep homage to the Omniscient Buddha for a full three months from 1st Waning of Waso to Fullmoon of Thadingyut. According to the Vinaya rules of the Buddha, the period of a full three months from 1st Waning of Waso to Fullmoon of Thadingyut (round about from mid-July to mid-October) is retreat-period of Buddhists. During retreat-period, all Buddhist monks must not have to go away from their residence

(monasteries, temples) not more than seven days. Especially, they have to fulfil their religious duties (Ganthadhura and Vipassanadhura) during the retreat-period more than before. All Buddhist monks have followed and practised the said Vinaya rules since over 2500 years ago.

When the Buddha descended from Tavatimsa (Celestial abode), the Devas and Brahmas accompanied Him putting up white sacred umbrellas and fanning Him. At that time, because of unlimited miraculous powers, supernormal powers and glory of the Buddha, the whole earthings could see the magnificent celestial abode, and also the Devas and Brahmas could see hundreds of thousands of millions of people greeting and paying deep homage to the Buddha who descended at the gate of Sankassa Town of the human abode on the Fullmoon Day of Thadingyut (Mahapavarana Day).

The Fullmoon Day of Thadingyut (Mahapavarana Day) has been marked by Buddhists as the significant and noble day of Abhidhamma since then (over 2500 years ago). On the auspicious occasion of the Abhidhamma (Mahapavarana Day), in remembrance of the Buddha, members of the Sangha recite Abhidhamma discourses, and multifarious Buddhist devotees offer lights, water, flowers, incense, fragrant scents, fruits and other offertories. And also, Dhamma talks about Abhidhamma (Mahapavarana) Day are held. On this noble day, most Buddhists keep nine precepts for their meritorious deeds dedicating to the attainment of noble stage of Nibbana (supreme bliss).

The Pali term Abhidhamma is composed of Abhi which means subtle or ultimate, and Dhamma which means truth or doctrine. The Abhidhamma, therefore, means subtle or ultimate truth or doctrine. The Abhidhamma Pitaka consists of the four ultimate things, Mind (Citta), Psychicfactor (Cetasikas), Matter (Rupa) and Nibbana. It is the most important and most interesting to a deep thinker. It is subdivided into seven

books.

When the Buddha had preached Abhidhamma for a full three months to His deceased mother who was reborn as Santusita Deva and to other Devas and Brahmas at the celestial abode, He said to the king of the celestials that He would return to the human abode. Therefore, the king of the celestials created and arranged three stairways of silver, gold and ruby beginning from the top of the great Mount Meru to the gate of Sankassa Town of the human abode.

Sending forth the six coloured rays emanated from His body, the Buddha descended by the middle stairway of ruby to the gate of Sankassa Town of the human abode (on earth). The Devas (Celestial beings) accompanied the Buddha from the right side stairway of gold playing musical instruments and fanning the Buddha. The Brahmas (higher celestial beings) accompanied the Buddha from the left side stairway of silver putting up white umbrellas.

At the time, when the Buddha returned from the celestial abode to the human abode, the highest Brahma realm, Ekamanta, the lowest Aviji (Apaya planes of miserable existences), the four cardinal points, the ten directions and thousands of worlds were clearly visible without any blockage and barrier because of unlimited miraculous powers, supernormal powers and glory of the Buddha.

People could see the whole celestial abode, Devas and Brahmas, and all celestial beings in turn viewed more than hundreds of thousands of millions of people who were welcoming and paying deep homage to the Buddha. There was no one that did not wish and pray to become a Buddha, the most noble wish after witnessing the most surpassing splendour.

Up to this day, we can visualize the most surpassing splendour and significant event of the Omniscient Buddha descending to the earth from the great Mount Meru accompanied by Devas and Brahmas to the gate of Sankassa Town of the human abode.

On the Fullmoon Day of Thadingyut, we all Buddhists generously offer lights, water, flowers, scents, fruits, food and other various kinds of offertories to pagodas and monasteries and also pay respect to teachers, parents and elders. These meritorious deeds dedicate to the attainment of the noble stage of Nibbana through the most surpassing splendour and significant event of the Omniscient Buddha descending to the human abode from the celestial abode on the Fullmoon Day of Thadingyut.

* * *

People could see the whole celestial abode, Devas and Brahmas, and all celestial beings in turn viewed more than hundreds of thousands of millions of people who were welcoming and paying deep homage to the Buddha. There was no one that did not wish and pray to become a Buddha, the most noble wish after witnessing the most surpassing splendour.

Mass rallies to support and welcome National Convention and Constitution organized in five townships of Yangon South District

YANGON, 26 Oct — Mass rallies to support and welcome the National Convention and forthcoming Constitution were held in Thanlyin, Kyauktan, Thongwa, Kayan and Seikkyi-Khanaungto townships yesterday.

In Thanlyin Township, about 11,500 people from two columns took positions at Thihadipa Sports Ground. Principal Dr Thein Tun of Cooperative Degree College presided over the mass rally together with members of the panel of chairmen Captain Tint Swe (Retd) of War Veterans Organization, Daw Myint Yi of Township Women's Affairs Organization, Daw Kyaing Kyaing Aye of Township Maternal and Child Welfare Association, U Hla Tun of Township Union Solidarity and Development Association and townsenders U Khin

Hlaing and U Myint Thein.

U Yan Naing Shwe of USDA tabled a motion calling for the support of the National Convention and forthcoming Constitution, and Daw Win Win Aye Khaing of Township WVO, Daw Soe Soe San of Township MCWA, Captain Sein Win (Retd) of Township WVO and townselder U Myint Win seconded the motion. Later, the mass rally ended with chanting of slogans, after seeking the approval from the attendees.

In Kyauktan, over 10,000 people attended the mass rally at Sancheinmi Sports Ground. Townselder former electrical engineer U Tun Hla Shwe presided over the mass rally together with members of the panel of chairmen.

U Maung Maung Tar of USDA tabled a motion, and Daw Cho



The attendees chanting slogans at the ceremony to support National Convention and forthcoming constitution.—MNA

Cho Aye of Township WAO, Daw Kyi Kyi Htoo San of Township MCWA, U Win Khaing of Township WVO and townselder U Min Zaw seconded the motion. The mass rally ended with chanting of the slogans, after seeking the approval from those present.

A similar mass rally was held at Bayintnaung Sports Ground in Thongwa. Over 11,000 people participated in the mass rally, presided over by townselder U Thaung Shwe and members of the panel of chairmen.

U Aye Khaing of USDA tabled a motion, and Daw Than Yu Swe of Township WAO, Daw Nwe Ni Hlaing of Township MCWA, U Moe Thet of Township WVO and townselder U Kyaw Thein seconded the motion. Later, those present approved the motion and chanted slogans at the end of the mass rally.

In Kayan, over 10,000 people attended the mass rally. It was presided over by entrepreneur U Aye Ko together with members of the panel of chairmen.

U Win Swe of USDA, Daw Khin Aye Maw of Township WAO, Daw Yi Yi Lwin of Township MCWA, U Min Aung of Township WVO and townselder U Myint Thein seconded the motion. The mass rally ended with chanting of the slogans, seeking the approval from the people.

A similar mass rally was held in Seikkyi-khanaungto. Over 5,500 people attended it. Townselder U Tin Win presided over the mass rally together with members of the panel of

chairmen. U Myo Zeyar Win of USDA tabled a motion calling for the support of the National Convention and forthcoming Constitution. Daw Khaing Nyein Aye of Township WAO, Daw Win Win Mar of Township MCWA, U Tun Hlaing of Township WVO and townselder U Than Naing seconded the motion. Later, those present chanted slogans at the conclusion of the mass rally and approved the motion. — MNA

Performing Arts Competitions Work Committee meets

NAY PYI TAW, 26 Oct — A coordination meeting between members of the Work Committee for Organizing the 15th Myanmar Traditional Cultural Performing Arts Competitions, members of the panel of judges for marionette contest and supervisors from state and division teams was held at No 7 Transit Centre in Nay Pyi Taw Ywadow this afternoon.

Secretary of the Work Committee Director-General of Fine Arts Department U Yan Naing Oo made a speech on the occasion.

Then, officials of the work committee and panel of judges for the marionette contest and supervisors reported on their respective sectors.

Later, the secretary gave necessary instructions. — MNA

People of Rakhine State, Shan State (East), Mon State, Magway Division, Yangon Division march in procession to denounce recent protests

NAY PYI TAW, 26 Oct —The people of Rakhine State, Shan State (East), Mon State, Magway Division and Yangon Division who wish to see stability of the State, the rule of law and community peace and tranquillity regarded recent protests instigated by some monks and NLD members as a threat to peace and stability. So, they walked in procession to denounce such protests on 11, 12, 14, 22, 23 and 24 October after seeking permission from the authorities concerned.

On 11, 12 and 14 October more than 12000 people each of Pauktaw, Myaybon, MraukU, Ponnagyun, Maungtaw

and Buthidaung townships in Rakhine State marched in procession shouting slogans in support of Our Three Main National Causes and the forthcoming constitution.

On 23 and 24 October about 15,000 people each of Mongyan, Mongton, Mongphyat, Kengtung, Monghsat, Mongkhat and Mongyawng townships in Shan State (East) marched in procession, shouting slogans and holding placards.

On 22 and 23 October about 20,000 people each of Thaton, Mudon, Kyaikhto and Theinbyuzayat townships in Mon State marched in procession, shouting

slogans and holding placards.

On 23, 24 and 25 October about 10,000 people each of Yenangyoung, Myaing, Saw, Minhla, Ngaphe, Mindon, Salin, Minbu,

Pwintbyu and Aunglan townships in Magway Division marched in procession shouting slogans and holding placards.

Likewise, on 24 and 25 October about

10,000 people each of Hlegu and Seikkyi-Khanaungto townships in Yangon Division marched in procession shouting slogans and holding placards.

MNA



Local residents of Mongyawng Township condemning the recent protests.—MNA

Abhidhamma Day ceremonies held at famous pagodas, ...

(from page 1)
the devotees. The Pagoda Board of Trustees ob-

tion participated in recitation of Abhidhamma Desana.

the ceremony, the congregation offered alms to members of the Sangha.

tion of novices and monks from six monasteries in the precinct of the pagoda. The Abhidhamma Day was observed at Kyaikwaing Pagoda. Members of the pagoda board of trustees and religious associations recited Abhidhamma Gathas.

At Koedatgyi Pagoda, wellwishers offered 'soon' and fruit to the Buddha Image this morning. After organizing the Dhamma Puja programmes, wellwishers served those present with refreshments.

Likewise, Maha Wizaya, Lawka Chantha Abhaya Labha Muni Buddha Image, Meilamu Pagoda, Kyaikkasan Pagoda and other famous pagodas and stupas in

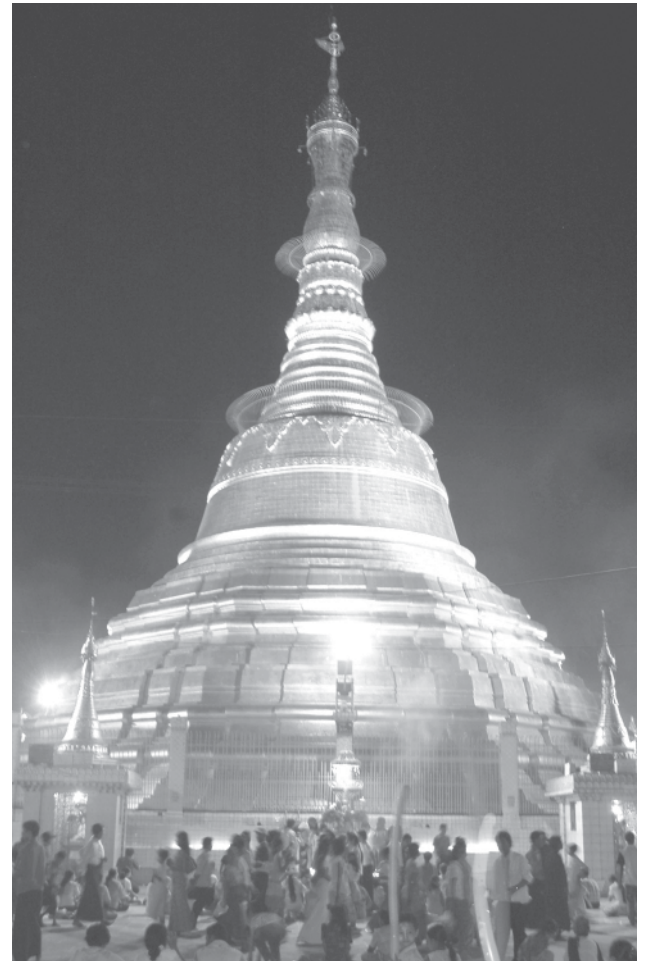

Shwephonepwint Pagoda being illuminated on Fullmoon Day of Thadingyut.

MNA

Yangon were packed with devotees and pilgrims and multi-colored lights were offered in the evening.

MNA



The Shwedagon Pagoda being packed with worshippers on Fullmoon Day of Thadingyut.—MNA

served the Abhidhamma Day at Kaba Aye Pagoda in Mayangon Township this afternoon. Members of the religious associa-

The 10th Abhidhamma Day ceremony was held at Buddha Tooth Relic Pagoda (Yangon) in Mayangon Township. At

At Shwephonepwint Pagoda in Pazundaung Township, the 30th Pavarana Ceremony was held with the participa-



Rice offering ceremony in progress at the Shwedagon Pagoda on Fullmoon Day of Thadingyut.—MNA



Abhidhamma Day (Fullmoon Day of Thadingyut) ceremony being held at the Buddha Tooth Relic Pagoda (Yangon).—MNA



Dhamma Puja Mingala ceremony in progress at Thiri Mingala Kaba Aye Pagoda.—MNA



The 30th Pavarana ceremony being held at Shwephonepwint Pagoda. MNA

Lt-Gen Ye Myint attends donation ceremony for U Pwa Hsutaungpyae Pagoda, Dekkhinayama Phayagyi Monastery in Chanmyathazi Township

NAY PYI TAW, 26 Oct — The donation ceremony for all-round renovation of U Pwa Hsutaungpyae Pagoda and the rice offering ceremony of Mandalay Division Peace and Development Council was held at Dekkhinayama Phayagyi Monastery in Chanmyathazi Township this morning.

Administrator Sayadaw Bhaddanta Karunã of Lepaw Monastery administered the Nine Precepts and members of the Sangha recited Parittas.

Member of the State Peace and Development Council Lt-Gen Ye Myint of the Ministry of Defence offered alms to Sayadaw Bhaddanta Karunã. Chairman of Mandalay Division PDC Commander of Central Command Maj-Gen Khin Zaw and wife donated provisions to Presiding Nayaka Sayadaw

Bhaddanta Mahinda of Minmar Okkyaung.

Mandalay Mayor Brig-Gen Phone Zaw Han and wife presented offertories to Presiding Nayaka of Hsinmin Monastery Agga Maha Pandita Bhaddanta Obhasabhivamsa. Senior military officers and departmental officials also donated provisions to members of the Sangha.

Lt-Gen Ye Myint accepted K 4 million for all-round renovation of the pagoda donated by Mandalay Division PDC through Commander Maj-Gen Khin Zaw; K 1 million by Mandalay City Development Committee through Mayor Brig-Gen Phone Zaw Han; K 200,000 by U Sein Win-Daw Tin Hla of Min Construction and K 300,000 by U Myint Wai-Daw Nu Nu of Shwe Ngar family.

Next, Lt-Gen Ye Myint and wife Dr Daw Tin Lin Myint offered 50

bags each of cement for all-round renovation of the pagoda and Dekkhinayama Phayagyi Monastery to Nayar Sayadaw.

The commander donated 50 bags of cement for all-round renovation of the pagoda and 100 bags of rice for members of the Sangha of Dekkhinayama Phayagyi Monastery.

Member of State Sangha Maha Nayaka Committee Phayagyi Taik Atulakari Hsinmin Monastery Sayadaw Agga Maha Pandita Bhaddanta Obhasabhivamsa delivered a sermon, and Lt-Gen Ye Myint and party shared merits gained.

Also present on the occasion were U Zagaragyi Monastery Presiding Nayaka Sayadaw Bhaddanta Sobhanabhivamsa, Dagon Monastery Sayadaw Bhaddanta Pandita, Eiksathaya



Lt-Gen Ye Myint offers provisions to a Sayadaw.—MNA

Weikza Monastery Sayadaw Bhaddanta Sunanda, Gunawady Monastery Sayadaw Agga Maha Pandita Bhaddanta Kusalaçarabhivamsa, Tampawady Monastery Sayadaw Agga Maha Ganthavaçaka Pandita Bhaddanta Obhasa, Amarapura Monastery Sayadaw Bhaddanta Kavinda, Thanhlaing

Yadana Okkyaung Sayadaw Bhaddanta Çakkinda and Azarni Monastery Sayadaw Bhaddanta Nandavamsa and disciples.

Next, Lt-Gen Ye Myint and party paid homage to U Pwa Hsutaungpyae Pagoda and offered lights and joss sticks to the Buddha Image at the pagoda.

After attending

to the needs of all-round renovation tasks at the pagoda, Lt-Gen Ye Myint left.

U Pwa Hsutaungpyae Pagoda was built in 1209 Myanmar Era, and it is 96 feet and eight inches high. Today's donations to the pagoda totalled 100 bags of cement and K 5.5 million.

MNA

Myanmar Human Rights Committee holds coord meeting No 1/2007

NAY PYI TAW, 26 Oct — The Myanmar Human Rights Committee held coordination meeting No 1/2007 at the hall of the Ministry of Home Affairs, here, yesterday afternoon.

Speaking on the occasion, Chairman of the Committee Minister for Home Affairs Maj-Gen Maung Oo said that the Myanmar Human Rights Committee was formed on 26 April 2000. The committee set up

nine subcommittees namely the home affairs subcommittee, the legal affairs subcommittee, the social affairs subcommittee, the labour subcommittee, the health subcommittee, the education subcommittee, the international affairs subcommittee, the religious affairs subcommittee and the women's affairs subcommittee, and allotted their duties and functions. Myanmar, being a member of the United Nations, is

observing the Universal Declaration of Human Rights. In addition, Myanmar is upholding the provisions of the Geneva Convention, the Convention on the Rights of the Child, the Convention No 29 for Forced Labour and the Convention on the Elimination of All Forms of Discrimination Against Women and the Convention on the Prevention and Punishment of the Crime of Genocide.

He added that some big countries are making one-sided and slanderous accusations of human rights against small nations for realizing their neo-colonialism. In conclusion, the minister urged the Myanmar Human Rights Committee and its subcommittees to carry out their respective tasks and to disseminate their accomplishments to the Myanmar people and international communities.

Also present at the meeting were members of the Myanmar Human Rights Committee who participated in the discussions. — MNA



Minister Maj-Gen Maung Oo addresses coordination meeting No 1/2007 of Myanmar Human Rights Committee.—MNA

All this needs to be known

- * Do not be frightened whenever intimidated
- * Do not be bolstered whenever flattered
- * Do not be softened whenever appeased

15th Myanmar Traditional Cultural Performing Arts Competitions continue for 9th day

NAY PYI TAW, 26 Oct — Chairman of the Leading Committee for Organizing the 15th Myanmar Traditional Cultural Performing Arts Competitions Commander of Nay Pyi Taw Command Maj-Gen Wai Lwin, Minister for Education Dr Chan Nyein, Minister for Health Dr Kyaw Myint, Deputy Minister for Education U Myo Nyunt, Deputy Minister for Health Dr Paing Soe, Deputy Attorney-General U Tun Tun Oo, Secretary of Work Committee for Organizing the Competitions Director-General U Yan Naing Oo of Fine Arts Department, officials, traditional cultural troupes, family members of regiments and units under Nay Pyi Taw Command and local people enjoyed the performance of the contestants in the Performing Arts Competitions at the designated places in Nay Pyi Taw Yezin, here, today.

In the 9th day programmes of the competitions, Chairperson of the panel of judges Assistant Director (Music) (Retd) Daw Tin Tin Mya of Myanma Radio and Television and party supervised the singing contests at University of Agriculture. A total of 16 contestants participated in the amateur level (second class) men's old/modern song contest and 15 students in the basic education level (10-15 age group) girls' old/modern song contest.

At University of Veterinary Science, Chairman of the panel of judges Rector U Tin Soe of University of Culture (Yangon) and party supervised the Kwetseik (narration of Jataka stories) contests. Five persons



Commander Maj-Gen Wai Lwin enjoys basic education level (10-15 age group) girls' mandolin contest.—MNA

competed in the amateur level (first class) narration of Jataka stories contest.

Chairman of the panel of judges Chairman of Myanmar Music Asiayon U Maung Maung Latt and party supervised the song composing contest at Agricultural Research Department. A total of 10 students participated in the higher education level men's and women's song composing contest.

In the mandolin contests supervised by leader of the panel of judges U Maung Hmi and party at Forest Research Division, eight students took part in the basic education level (10-15 age group) boys' mandolin contest, seven students in the girls' contest and two students each in the basic education level (5-10 age group) boys' and girls' mandolin contests.

At University of Agriculture, Chairman of the panel of judges U Yee Nwe and party supervised the harp contests. Six contestants participated in the amateur level (second class) women's harp contest, four students in the basic education level (5-10 age group) boys' harp contest, four men and two women in the higher education level harp contests.

In the orchestra contest at the convocation hall of University of Agriculture, leader of the panel of judges U Sein Satin and party supervised the amateur level women's orchestra solo contest with the participation of five contestants, the basic education level (15-20 age group) girls' orchestra solo contest with three students and the (10-15 age group) girls' orchestra solo contest with six students. — MNA

Energy Minister receives counterpart of Republic of Kalmykia



Minister for Energy Brig-Gen Lun Thi receives Energy Minister Mr Chedyrov Boris of Republic of Kalmykia of Russian Federation and Russian Ambassador to Myanmar Dr Mikhail M Mgeladze.—MNA

NAY PYI TAW, 26 Oct—Minister for Energy Brig-Gen Lun Thi yesterday afternoon received a visiting delegation led by Minister of Energy Mr Chedyrov Boris of the Republic of Kalmykia of the Russian Federation and Russian Ambassador to Myanmar Dr Mikhail M Mgeladze at his office, here. They discussed matters related to development

of the energy sector. Also present at the call were Deputy Minister Brig-Gen Than Htay, the acting director-general and managing directors of the department and enterprises under the ministry.—MNA

Journalists of ASEAN nations tour downtown Yangon

YANGON, 26 Oct—An 18-member journalist delegation of ASEAN nations this morning visited Myanma Radio and Television where they heard a report presented by Director-General of MRTV U Khin Maung Htay on functions of the department.

Next, the delegation viewed the recording of vocalists and videotaping of dancing.

In the afternoon, they proceeded to IHBC Promotion Hall on Bo Aung Kyaw Street. At the briefing hall, Chairman of Myanmar Writers and Journalists Association U Hla Myaing (Ko Hsaung) extended greetings to the journalist delegation and Secretary of MWJA Dr Tin Tun Oo explained the salient points of the association.

Afterwards, executives replied to the queries raised by the journalists.

Later, they visited Myanmar Times Journal House on Bo Aung Kyaw Street.

In the evening, they paid homage to Shwedagon Pagoda.

MNA



Journalists of ASEAN countries visit Myanma Radio and Television.—MNA

The best time to plant a tree was 20 years ago. The second best time is now.

Suvannasama Drama Contest

Dr Khin Maung Nyunt

The 15th Myanmar Traditional Cultural Performing Arts Competitions have commenced in Nay Pyi Taw since 17 October 2007 with the objectives — **to vitalize patriotism and nationalism that is based on strong Union Spirit, to ensure uplift of national prestige and integrity and preservation and safeguarding of cultural heritage and national character, to ensure flourishing of Myanmar music, dance and traditional fine arts, and to prevent the influence of alien culture.**

The essence of the Myanmar Traditional Cultural Performing Arts Competitions is to preserve and promote Myanmar culture and national character. The Myanmar Traditional Cultural Performing Arts Competitions are held annually with this essence to preserve Myanmar traditional heritage, to hand down Myanmar culture and cultural norms to younger generations and to preserve national prestige and integrity.

The 15th Myanmar Traditional Cultural Performing Arts Competitions include the Drama Contest of Suvannasama, the third of the ten jataka stories of the Buddha. Suvannasama Jataka story is relating to Perfection in Truthfulness. The brief story is as follows:

A fisherman living in Dagama village near

age. However, they abstained from unchastity, so they refused to accept the suggestion. The king of celestial beings again suggested that Dukula rub softly the navel of Parika with his palm. That time, they accepted the suggestion. Then, they got a son with a golden complexion and so they named him “Suvannasama”. When the boy came of age, he helped his old parents with their household chores.

One day, Dukula and Parika went around the forest in search for fruit. They confronted a snake taking shelter from rain under a tree and lost their eyesight due to the poisonous vapour of the angry serpent. Then, Suvannasama promised that he would look after them forever. He searched fruit and fetched water from the river every day with the help of tame deer.

Being excessively fond of the meat of deer, King Pilhi Yakkha of Baranasi handed over his throne to his mother and lived in the forest hunting deer and having deer meat. One day, he saw Suvannasama, who was on his way to the river with deer to fetch water. Wondering if Suvannasama among deer was a human being, a celestial being or a dragon, the king shot an arrow at him to the ground. When he approached Suvannasama, the latter gently asked why the king shot the arrow at him. The king explained his true story and bad habit to Suvannasama. When the king knew that Suvannasama

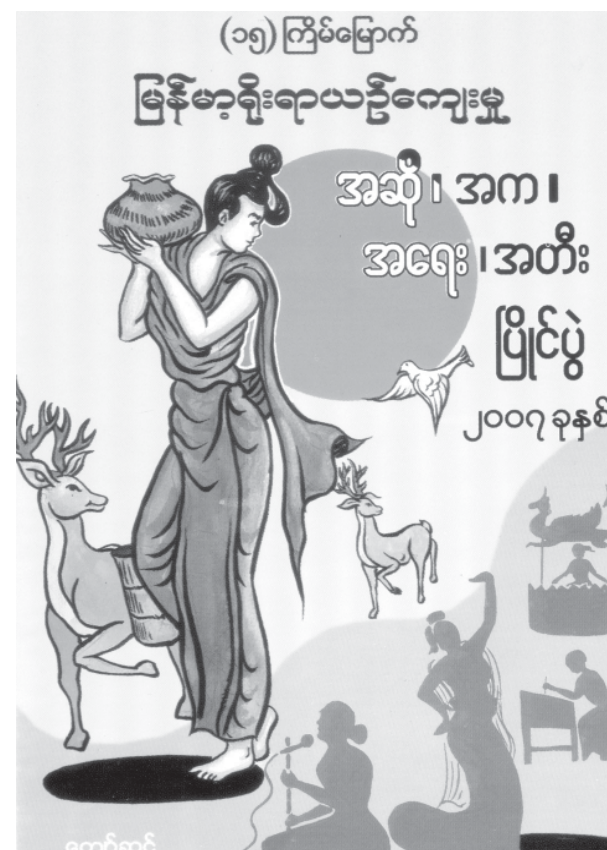

the forest Bahu Sundari appeared and also took declaration on oath. Then, Suvannasama survived the poison of the arrow. The parents regained their eyesight. After listening to the sermon of Suvannasama, King Pilhi Yakkha gave up his bad habit and returned to the palace and ruled the country in accordance with the ten precepts of a king ever after.

In the last act of the drama, Suvannasama became Buddha Gotama; King Pilhi Yakkha, Great Disciple Ananda; goddess Bahu Sundari, Bikkhuni Uppalavan; the king of the celestial beings, Great Disciple Anuruddha; Dukula, Great Disciple Maha Kassapa; and Parika, Bikkhuni Bhaddaka Pilani.

Among the ten ways of speaking, Otan Sankhat (tactic of expressing oneself in a way appropriate to the situation) was referred to the final part of Suvannasama Drama.

After the declaration of oath of Suvannasama’s parents and goddess Bahu Sundari, the king of the celestial beings asked what the parents wanted— (1) the survival of their son, (2) regaining their eyesight, or (3) getting a pot full of gold. Dukula and Parika replied that they wanted to see their son shouldering a pot full of gold. Their answer was to have all their three wishes fulfilled with one stroke.

As a gesture of honouring the 15th Myanmar Traditional Cultural Performing Arts Competitions, I write this article about Suvannasama Drama Competition being held to help set up more national cultural milestones.

Translation: MS

Myanma Alin: 23-10-2007

The essence of the Myanmar Traditional Cultural Performing Arts Competitions is to preserve and promote Myanmar culture and national character. The Myanmar Traditional Cultural Performing Arts Competitions are held annually with this essence to preserve Myanmar traditional heritage, to hand down Myanmar culture and cultural norms to younger generations and to preserve national prestige and integrity.

Baranasi Province and another fisherman living on the other bank of the river were friends. They promised each other that if either of them would have a son and the other, a daughter, they would have to hold a wedding reception of the two children. Later, one got a son named “Dukula” and the other, a daughter named “Parika”. When they came of age, the parents of the two sides put their promises into deeds. Being descended from higher celestial beings, the new couple hated to lead a married life. So, they renounced the world and lived in solitude in Himalayan forest.

The king of celestial beings suggested that they have a sexual relation so that they would get a child who would look after them when they were at old

was looking after his old parents, the king felt sorry and regretted over his act and solemnly pledged that he would look after Suvannasama’s parents forever on his behalf.

The king thought unconscious Suvannama was dead, and went to the hermitage and explained the incident to the two hermits. He also pledged he would look after them on behalf of Suvannasama. However, they refused his proposal and asked him to lead them to their son.

The two blind persons felt their son and found that he was just unconscious due to the poison arrow. So, the two said words of asseveration truth for their son’s survival of the injury. After their words, the goddess of

ADVERTISEMENT

ပြန်ကြားရေးဝန်ကြီးဌာန

သတင်းနှင့်စာနယ်ဇင်းလုပ်ငန်းအတွက် စက်ပစ္စည်းများဝယ်ယူရန်တင်ဒါခေါ်ယူခြင်း

၁။ ပြန်ကြားရေးဝန်ကြီးဌာန၊ သတင်းနှင့်စာနယ်ဇင်းလုပ်ငန်းအတွက် အသုံးပြုရန်လိုအပ်သောအောက်ဖော်ပြပါစက်ပစ္စည်းများကို ဝယ်ယူလိုပါသည်။

- ၁။ Computer Pentium 4 ၁၈-လုံး
- ၂။ Laser Printer A4 ၃-လုံး
- ၃။ Laser Printer A3 ၁-လုံး
- ၄။ Dot Printer ၂-လုံး
- ၅။ Copier ၁-လုံး
- ၆။ Forklift (2 Tons) ၁-လုံး
- ၇။ မီးစက် 150 KVA ၁-လုံး

၂။ တင်ဒါပေးသွင်းမှုကို (၉-၁၁-၂၀၀၇)ရက်(၁၆:၃၀)တွင် ပိတ်ပါမည်။

၃။ တင်ဒါပုံစံနှင့်အသေးစိတ်အချက်အလက်များကိုအောက်ပါ လိပ်စာတွင်လာရောက်စုံစမ်းဝယ်ယူနိုင်ပါသည်။

ပြည်တွင်း/ပြည်ပ ပစ္စည်းများဝယ်ယူရေးနှင့်ထွဲရောင်းချရေးကော်မတီ
ပြည်ကြားရေးဝန်ကြီးဌာန
မြန်မာ့အသံနှင့်ရုပ်မြင်သံကြား
ပြည်လမ်းရန်ကုန်မြို့
ဖုန်း-၅၃၇၆၅၅

CLAIMS DAY NOTICE

MV VASCO DA GAMA VOY NO (069)

Consignees of cargo carried on MV VASCO DA GAMA VOY NO (069) are hereby notified that the vessel will be arriving on 27.10.2007 and cargo will be discharged into the premises of A.W.P.T where it will lie at the consignee's risk and expenses and subject to the byelaws and conditions of the Port of Yangon.

Damaged cargo will be surveyed daily from 8 am to 11:20 am and 12 noon to 4 pm up to Claims Day now declared as the third day after final discharge of cargo from the vessel.

No claims against this vessel will be admitted after the Claims Day.

**SHIPPING AGENCY DEPARTMENT
MYANMA PORT AUTHORITY
AGENT FOR: M/S INTERASIA LINES**

Phone No: 256908/378316/376797

FAO warns bird flu virus in Europe as hidden danger

ROME, 26 Oct—The avian influenza virus H5N1 could become entrenched in chickens and domestic ducks and geese in parts of Europe, the UN Food and Agriculture Organization (FAO) warned on Thursday.

The agency stressed that healthy domestic ducks and geese may transmit the virus to chickens and play a more important role in the persistence of the virus in the region than previously thought. H5N1 surveillance in countries with significant domestic duck and geese populations should be urgently increased.

FAO's warning followed the detection of H5N1 in diseased young domestic ducks by German scientists.

"It seems that a new chapter in the evolution of avian influenza may be unfolding silently in the heart of Europe," said FAO's Chief Veterinary Officer, Joseph Domenech. "If it turns out to be

true that the H5N1 virus can persist in apparently healthy domestic duck and geese populations, then countries need to urgently reinforce their monitoring and surveillance schemes in all regions with significant duck and geese production for the presence of H5N1."

"Europe should prepare for further waves of avian influenza outbreaks, most probably in an east-west direction, if the virus succeeds in persisting throughout the year in domestic waterfowl. This heightens the need for increased surveillance and monitoring of possible virus circulation in domestic ducks and geese," Domenech said.

Based on its experience in fighting avian influenza around the world over the past three years, FAO considers that risk assessment, surveillance and virus search strategies should be reviewed, Domenech said.

Internet

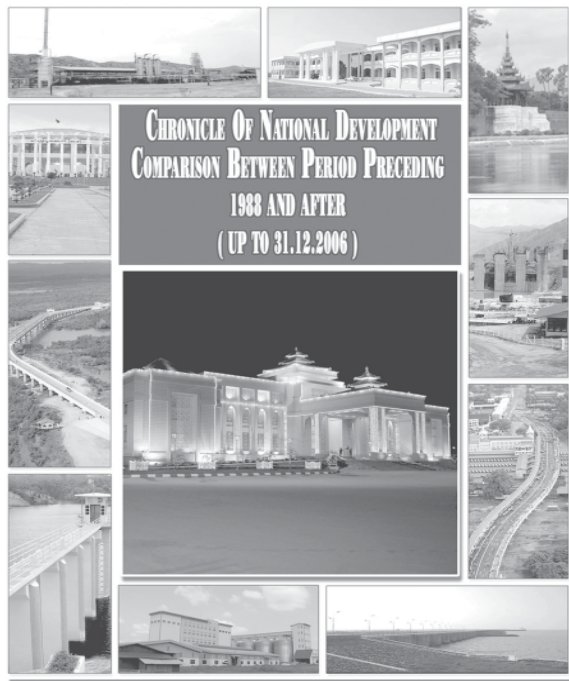

**CHRONICLE OF NATIONAL DEVELOPMENT
COMPARISON BETWEEN PERIOD PRECEDING 1988 AND AFTER (UP TO 31 - 12 - 2006)**

- * This book features firm evidences, correct data and figures and documentary photos.
- * This book reflects the success in building the infrastructure according to the political, economic and social objectives for the brighter future of the State.
- * Illustrated with charts and colourful photos.
- * Published by the Ministry of Information.

Now On Sale USD 3.00

Available at

- Sarpay Beikman Book Shop, 529-531, Merchant Street, Yangon ☎ 01-381448, 249031
- Sarpay Beikman Book Shop, No-55, Thabyaygon Market, Nay Pyi Taw
- News and Periodicals Enterprise Book Shop, 212, Theinbyu Street, Yangon ☎ 294306
- Hotels, Supermarkets and Shopping Malls in Yangon.

MYANMAR IVANHOE COPPER COMPANY LIMITED (TENDER NOTICE)

TENDER IFB No. EME&TRUCKS-RENT-07

Rental of 320 sized excavator and 12 tonne trucks to the S & K Mine site, west bank of Monywa, Myanmar.

CLOSING DATE & TIME: 9th November 2007

Tender documents are available at the following address queries can be done between 10 am to 4 pm at MICCL. Yangon office before the tender closing date.

Myanmar Ivanhoe Copper Company Limited

70(I) Bo Chein Street, Pyay Road, Hlaing Township
Yangon, Myanmar (Tel: (95) 1 514194 to 7/ Fax: (95) 1 514208/ Email: miccl@miccl.com.mm)

Second person dies in California wildfires

LOS ANGELES, 25 Oct—A second person died on Tuesday in the raging wildfires sweeping across Southern California, authorities said.

The individual, who

was not immediately identified, was caught in the 38,000-acre (15,380-hectare) Buckweed Fire fire north of Los Angeles, US Forest Service spokesman Jason Kirchner said.

"We understand there was a civilian injury from the initial attack on the Buckweed Fire on Monday and that person succumbed to their injuries today," Kirchner said.— *MNA/Reuters*

All 54 trapped Australian gold miners rescued

SYDNEY, 25 Oct—All 54 miners trapped by fire underground at a gold mine in Western Australia have been rescued, the Australian Broadcasting Corporation reported on Wednesday.

The ABC's website said all 54 had been recovered and local authorities had begun an investigation into the incident.

The fire broke out in a caterpillar truck working underground at the Kanowna Belle gold mine, forcing the miners to shelter in refuge stations, Barrick Gold Corporation said.

"The fire has been extinguished by the onboard fire suppression system. As a precautionary measure the 54 employees working underground at the time proceeded to the refuge chambers," the company said in a statement. — *MNA/Reuters*



This image provided by publisher Microsoft Corp, shows Master Chief, the protagonist in the new video game 'Halo 3.' Microsoft Corp is scheduled to report fiscal first-quarter earnings after the closing bell on 25 Oct, 2007. Analysts expect the world's largest software maker to post a profit of 39 cents per share on \$12.57 billion in sales.—INTERNET

ပညာရေးဖြင့် ခေတ်မီပွံ့ပြားတိုးတက်သော နိုင်ငံတော်ကြီး တည်ဆောက်အံ့



A bee feeds on an almond tree blossom south of Athens. A clutch of scientific studies showing that the foraging patterns of albatrosses, bumblebees and deer conform to a single mathematical axiom all got it wrong, researchers said on Wednesday.

INTERNET

Portuguese biker to travel to Beijing Olympics overland

LISBON, 25 Oct — Portuguese motorcyclist Mario Cales told media Tuesday he planned to travel overland to the Beijing Olympic Games from Portugal in a four-month trip covering 11 European countries and eight Asian countries.

The trip will begin in Lisbon on 8 April next year and end on 8 August, the day of the Games' inauguration.

The overall distance will be about 30,000

kilometres, equivalent to more than three quarters of the Earth's diameter, and much longer than the straight-line distance to Beijing because he will not be travelling as the crow flies. Cales said the government and Portuguese exporters are sponsoring his travel, and he will give Press conferences on the trip, and

write a book on the journey, as well as recording it in photographs and on videos.

Cales, 40, a native of northern Portuguese city Oporto, is the author of the book *Relating Via Nature*.

He is a mental sciences professor in Oporto's Northern Professional University.

MNA/Xinhua

China's first lunar probe launch successful

XICHANG (Sichuan Province), 25 Oct — The launch of China's first lunar probe *Chang'e-1* was successful, a Chinese official announced Wednesday evening at the Xichang Satellite Launch Centre in southwest China's Sichuan Province.

Li Shangfu, director of the Xichang launch centre made the announcement after the orbiter successfully entered the earth orbit and unfolded its solar panel, paving the way for its transfer to the lunar orbit. Chinese President Hu Jintao extended his congratulations to all those who have worked for the lunar exploration programme shortly after the



A Long 3 March A rocket carrying the *Chang'e One* lunar orbiter blasts off from the Xichang Satellite Launch Centre in southwest China's Sichuan Province on 24 Oct, 2007. —INTERNET

official announcement of the launch's success.

The launch of the lunar probe "marks another milestone in China's aerospace programme after manmade satellites and manned space fl-

ights", said Chinese Vice-Premier Zeng Peiyan, who was watching the launch at the Xichang launch centre.

The launch of *Chang'e 1* means that China has taken a key step in its lunar

exploration programme.

It is a symbol of China's bid to build an innovative country, said Zeng.

Chang'e-1 blasted off on a *Long March 3A* carrier rocket at 6:05 pm (10:05 GMT) from the No 3 launching tower at the Xichang Satellite Launch Centre, the 15th successful launch in a row for the rocket. It is the first step of China's three-stage moon mission, which will lead to a moon landing and launch of a moon rover around 2012. In the third phase, another rover will land on the moon and return to earth with lunar soil and stone samples for scientific research around 2017. —MNA/Xinhua

Storm kills 18 Mexican oil workers, shuts ports

ILLAHERMOSA, 25 Oct — A storm killed 18 Mexican oil workers fleeing a battered offshore rig, and Navy rescue teams were searching on Wednesday for seven people missing in the turbulent seas.

State-owned oil monopoly Pemex said 61 people had been rescued after huge waves knocked the Usumacinta drilling platform into an adjacent rig late on Tuesday.

Workers on the rig, in

the Kab oil field in the southeastern Gulf of Mexico, had jumped into emergency rafts after the collision caused leaks in crude oil and natural gas pipes.

Exploration and Production Chief Carlos Morales called the accident one of the worst in Pemex's history.

The death toll could rise as bad weather hampered efforts by Navy rescue teams to locate other workers. —MNA/Reuters

Two of six mass murder victims in Canada innocent bystanders

OTTAWA, 25 Oct — Police released Tuesday the names of all six victims in the mass murder in western Canada, saying two of them were "innocent bystanders".

A police spokesman in Surrey, British Columbia released the names during a Press conference Tuesday. He said no arrests have been made and pleaded the public for providing more clues.

Ed Schellenberg, 55, a gas maintenance worker and Chris Mohan, 22, a student that lived in the building, were not connected to the other four and were "simply in the wrong place at the wrong time", said Royal Canadian Mounted Police

(RCMP) Superintendent Wayne Rideout.

The other four, including 22-year-old Edward Narong, 21-year-old Corey Lal, 26-year-old Michael Lal and 19-year-

old Ryan Barto-lomeo, are believed to have been involved in "a criminal lifestyle, criminal activity", he said.

He said investigators have reason to believe the

murders were linked to gang violence or organized crime, and were not part of a random attack. The two bystanders were murdered intentionally, he added. —MNA/Xinhua

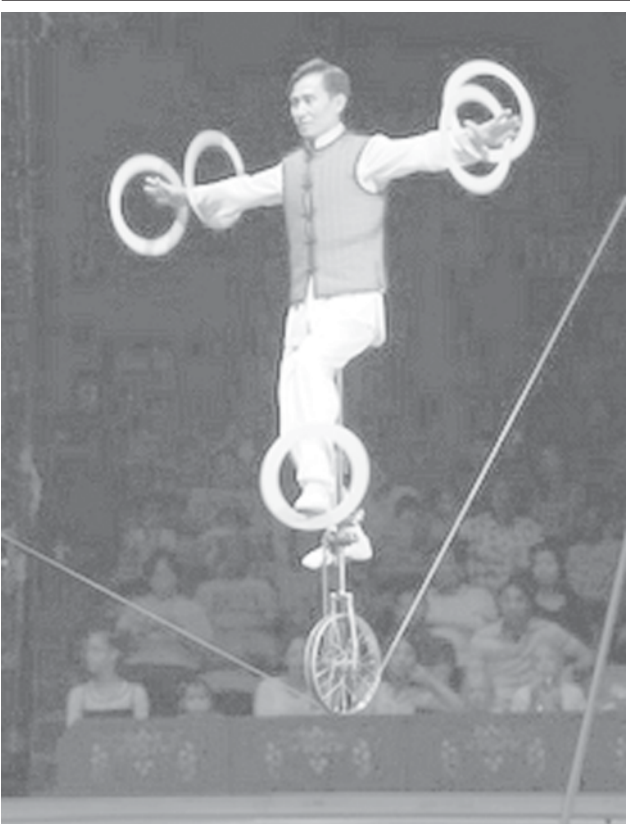

This photo released by the Big Apple Circus shows Cong Tian of China who returns to the Big Top with his incredible balancing feats on a slim slack-wire in 'Celebrate!' the all-new 30th anniversary show of the Big Apple Circus! —INTERNET



White tiger Rong Rong, 11, with her cubs born on 6 Sept this year at a zoo in Jinan, East China's Shandong Province on 23 Oct, 2007. Rong Rong has delivered 37 cubs, of which 31 survived. —XINHUA

SPORTS



Pan Yao (L1) from Guangzhou city competes during the men's K-1 (Kayak single) 12km finals at the Sixth Chinese City Games in Ezhou of central China's Hubei Province, on 25 Oct, 2007. Pan claimed the title of the event. — INTERNET

Staunton leaves Ireland managers job

DUBLIN, 25 Oct — Ireland have terminated the contract of national coach Steve Staunton by mutual consent, the Football Association of Ireland (FAI) said on their website on Wednesday.

FAI President David Blood thanked Staunton and his management team for their efforts since taking over in January 2006.

"They have brought through many young players and leave behind a squad with strong development potential," Blood said in a statement.

"As a member of the three-man committee which made the recommendation to appoint Stephen and his team, I am disappointed that things have not worked out the way I, Stephen or my colleagues on the Board expected."

Staunton, the former Ireland, Liverpool and Aston Villa defender, had come under renewed pressure after last week's 1-1 draw with Cyprus ended Ireland's hopes of qualifying for Euro 2008.

Ireland Under-21 team manager Don Givens will take temporary charge of the senior side for the final Euro 2008 qualifier against Wales on November 17. — MNA/Reuters



River Plate's Ariel Ortega (R) tries to break away from Defensor Sporting's Pablo Gaglianone during their quarter-final soccer match for the Copa Sudamericana in Montevideo on 25 Oct, 2007. INTERNET

Chelsea keeper wins damages over dog article

LONDON, 26 Oct — Chelsea goalkeeper Petr Cech accepted substantial libel damages on Thursday after an article in *The Sun* accused him of "callous, heartless and uncaring" behaviour following an incident with his dog.

Cech's dog and another, belonging to the partner of Sun columnist Kelvin MacKenzie, had been involved in a fight in January last year.

MacKenzie, a former editor of *The Sun* who now writes a column in the tabloid, had claimed Cech failed to apologize after his partner was knocked to the ground as the dogs clashed.

MacKenzie's partner, who was not named during proceedings at London's High Court, had been walking her dog near the footballer's home when her dog lurched towards Cech's.

During the disturbance, she was knocked off her feet by her own dog,

causing serious injury, the court heard from counsel for the Cechs, Jonathan Price. But in his column, MacKenzie accused Cech and his wife Martina of not only knowing the injury was caused by their dog but also of knowing that their dog was dangerous and that they were irresponsible dog owners.

Price told the judge the allegations were without foundation and had caused immense upset to the Cechs.

He continued: "The truth is that Mr and Mrs Cech take their responsibilities as dog owners very seriously and their dog is sensibly handled and cared for at all times." He told Mr Justice David Eady: "On hearing the commotion, Mr Cech came out of the house and removed his dog from the scene. Mrs Cech and another neighbour stayed with Mr MacKenzie's partner until an ambulance arrived." —MNA/Reuters

Japan's Reds reach Asian final after shootout

SAITAMA (Japan), 25 Oct — Japan's Urawa Reds squeezed into the Asian Champions League final after beating South Korean side Seongnam Ilhwa 5-3 on penalties on Wednesday.

The J-League champions were held 2-2 at home by the Koreans in a pulsating game to leave the tie locked at 4-4 on aggregate.

Urawa goalkeeper Ryota Tsuzuki saved Choi Sung-kuk's spot kick before Tadaaki Hirakawa smashed home the winning penalty as the Reds became the first Japanese side to reach the final.

"It's nice to get to the final but it should not be the end of the road," Reds manager Holger Osieck told reporters. "It was a close shave but now we want to go all the way."

The Reds will face either Iran's Sepahan or Al Wahda of the United Arab Emirates, who were playing their semifinal second leg in Abu Dhabi later on

Wednesday.

Sepahan lead 3-1 from the first leg.

Brazilian striker Washington, playing in a Zorro-like face mask to protect a broken nose, fired Urawa ahead with a clinical finish after 21 minutes.

But Seongnam equalized soon after the break when Choi finished a nice move from close range and then took a shock lead in the 69th minute through Kim Dong-hun. The visitors' joy lasted only four minutes, however, Makoto Hasebe rescuing the Reds after latching on to a clever flick-on from defender Tulio. — MNA/Reuters

Everton's Lee Carsley (R) challenges Larissa's Cleiton Alexandre Silva during their UEFA Cup Group A soccer match at Goodison Park in Liverpool, northern England, on 25 Oct, 2007. INTERNET

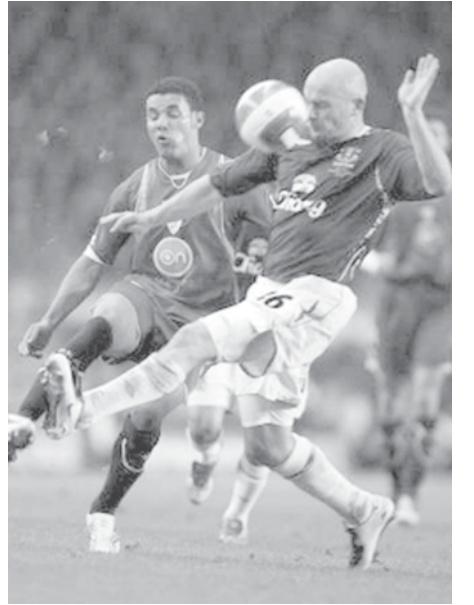

Guangzhou's Du wins men's 66 kilos judo title at Chinese city games

WUHAN (Central China), 26 Oct — Du Zhiyong crushed Uritublig of Wuhan in

ippon to win Guangzhou team the second judo gold in men's 66kg here Thursday at the Chinese City Games. In bronze medal playoff, Huang Wei from Kunming also siezed ippon to overcome Sqintu of Huhhot.

This is Guangzhou's second gold after Luo Hai clinched the men's 60 kilos on Wednesday.

Du, the champion at 2005 national youth championship, advanced into the final through a sudden death triumph over Sqintu of Huhhot. Du pulled out a koka at the Gold Score after a scoreless regular time. — MNA/Xinhua

Mexico's Chivas' Edgar Mejia, right, fights for the ball with Argentina's Arsenal's Alejandro Gomez during a Copa Sudamericana quarterfinals soccer game in Guadalajara, Mexico, on 25 Oct, 2007. INTERNET



Vasco go out on Romario's coaching debut

RIO DE JANEIRO, 25 Oct — Former Brazil striker Romario made his coaching debut on Wednesday but was unable to stop Vasco da Gama being knocked out of the Copa Sudamericana.

Vasco, with Romario taking a player-coaching role on an interim basis, beat Mexico's America 1-0 in the quarterfinal second leg but went out 2-1 on aggregate.

The former Barcelona and PSV Eindhoven player was appointed on Monday after Celso Roth became the second coach this year to be fired by the club.

Romario, 41, brought himself on as

a second-half substitute for his first game in four months and wasted a chance to level the aggregate scores when he mistimed a free header.

Leandro Amaral gave Vasco a 10th-minute lead following a corner but, despite creating a wealth of chances, the Brazilians were unable to find a second goal.

America goalkeeper Guillermo Ochoa made a superb save to deny Alan Kardec before halftime, while Luizao headed against the crossbar and the Mexicans cleared two balls off the line.

Brazil's interest in the tournament ended in Bogota where Sao Paulo were knocked out by Colombia's Millonarios, who won 2-0 to complete a surprise 3-0 aggregate win.

Despite struggling in the Colombian league, Millonarios dominated the game against the Brazilian champions and championship leaders.

Two late goals from captain Ricardo Ciciliano gave Millonarios victory on the night.

In the 77th minute, the shaven-headed striker met a cross with a first-time shot which found the bottom left hand corner of Rogerio Ceni's goal.

MNA/Reuters



Argentina's Juan Martin Del Potro returns a shot to Switzerland's Roger Federer during their second round match at the Swiss Indoors ATP tennis tournament in Basel, on 25 Oct, 2007. Federer won 6-1, 6-4. — INTERNET

US' war costs in Iraq, Afghanistan may top \$2.4 trillion

WASHINGTON, 26 Oct — The cost of the wars in Iraq and Afghanistan could total 2.4 trillion US dollars through the next decade, or 8,000 dollars per citizen, a congressional report said on Wednesday.

A previous estimate of 1.6 trillion dollars was upgraded to factor in interest, as both wars are being fought with borrowed money, the Congressional Budget Office (CBO) said in the report.

Of the 2.4 trillion dollars, 1.9 trillion will be used in Iraq, it said.

To date, the cost of the wars in Afghanistan

and Iraq have reached 604 billion dollars, according to the report.

Adjusted for inflation, that is higher than the cost of the Korean and Vietnam wars.

Prior to the March 2003 invasion of Iraq, the Bush Administration estimated the Iraq war would cost no more than 50 billion dollars.

The new estimate also includes President George W Bush's request Monday for another 46 billion dollars in war funding.

Sean Kevelighan, a spokesman for the White

House budget office, said, "Congress should stop playing politics with our troops by trying to artificially inflate war funding levels."

However, he declined to provide a White House estimate.

The CBO estimates assume that 75,000 troops will remain in Iraq and Afghanistan through 2017, including roughly 50,000 in Iraq.

While the burden of the war costs on the nation's overall economy is currently fairly small, the longer term effects of redirected investment and restricted borders could

hurt the competitiveness of the US.

Economists said one result of the war is most likely higher interest rates, as government borrowing means more bonds on the market, keeping bond prices low and yields high.

An estimate by the Centre for Economic and Policy Research said 10 years of war spending would cost the US 500,000 jobs and crimp economic output by 60 billion dollars a year.

MNA/Xinhua

Weather Map of Myanmar and Neighbouring Areas

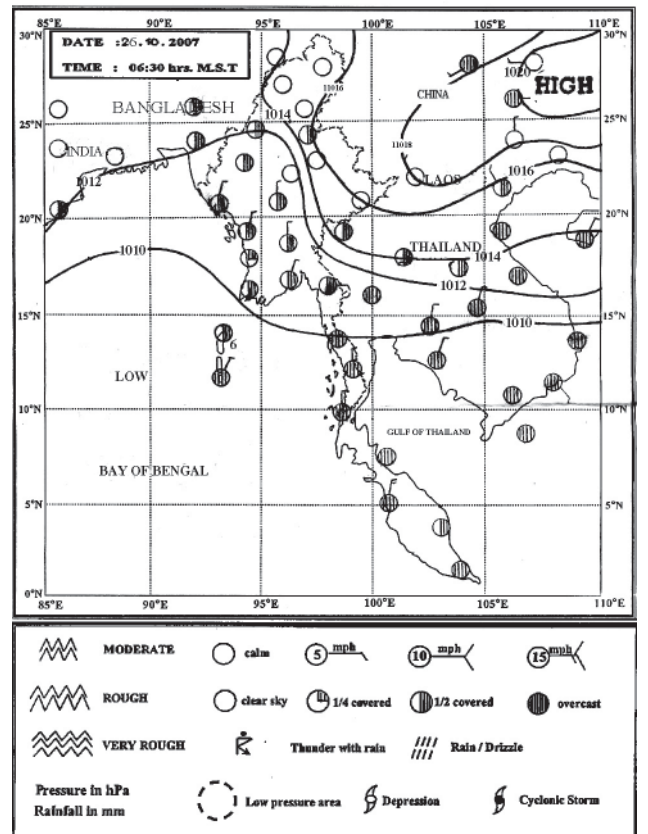

WEATHER

Friday, 26 October, 2007

Summary of observations recorded at 09:30 hours MST: During the past 24 hours, rain or thundershowers have been isolated in Mandalay, Yangon and Taninthayi Divisions and weather has been partly cloudy in the remaining areas. The noteworthy amounts of rainfall recorded were Co Co Island (0.23) inch, PyinOoLwin (0.19) inch and Kawthong (0.12) inch.

Maximum temperature on 25-10-2007 was 91°F. Minimum temperature on 26-10-2007 was 72°F. Relative humidity at 09:30 hours MST on 26-10-2007 was 79%. Total sunshine hours on 25-10-2007 was (7.8) hours approx.

Rainfall on 26-10-2007 was (Nil) at Mingaladon, Kaba-Aye and Central Yangon. Total rainfall since 1-1-2007 was (136.46) inches at Mingaladon, (140.75) inches at Kaba-Aye and (142.72) inches at Central Yangon. Maximum wind speed at Yangon (Kaba-Aye) was (5) mph from Northeast at (15:30) hour MST on 25-10-2007.

Bay inference: Weather is partly cloudy in the Andaman Sea and Bay of Bengal.

Forecast valid until evening of 27-10-2007: Likelihood of isolated rain or thundershowers in Rakhine, Shan, Mon and Kayin States, Taninthayi, Yangon, Ayeyawady and Bago Divisions and weather will be partly cloudy in the remaining areas. Degree of certainty is (60%).

State of the sea: Seas will be slight to moderate in Myanmar waters.

Outlook for subsequent two days: Generally fair weather in the whole country.

Forecast for Nay Pyi Taw and neighbouring area for 27-10-2007: Partly cloudy.

Forecast for Yangon and neighbouring area for 27-10-2007: Possibility of isolated rain or thunder-showers. Degree of certainty is (40%).

Forecast for Mandalay and neighbouring area for 27-10-2007: Partly cloudy.

Weather outlook for last weekend of October 2007: During the coming weekend, possibility of isolated rain or thundershowers Nay Pyi Taw, Yangon and Mandalay Divisions.



Saturday, 27 October
Tune in today

- 8:30 am Brief news
- 8:35 am Music -Sure
- 8:40 am Perspectives
- 8:45 am Music -One heart
- 8:50 am National news
- 9:00 am Music -Celebrity
- 9:05 am International news
- 9:10 am Music -Waiting
- 1:30 pm News /slogan
- 1:40 pm Music at your request -Like a rose -She's the one
- 9:00 pm ASEAN news Exchange news from ASEAN member countries
- 9:20 pm Myanma culture...Dr Khin Maung Nyunt -Thadingyut, the month of light festival II
- 9:30 pm Souvenirs -Tender feeling -Travelling light
- 9:45 pm News /Slogan
- 10:00 pm PEL



Saturday, 27 October
View on today

- 7:00 am
 1. ကျေးဇူးရှင်မင်းကွန်း ဆရာတော်ဘုရားကြီး၊ နိုင်ငံတော်သံယု မဟာနာယကအဖွဲ့၊ အကျိုးတော်ဆောင်ချုပ်၊ အဘိဓမ္မဟာရဋ္ဌဂုရု၊ အဘိဓမ္မအဂ္ဂမဟာ သဒ္ဓမ္မဇောတိက၊ တိပိဋကဓရ၊ ဓမ္မဘဏ္ဍာဂါရိက ဆရာတော် ဘဒ္ဒန္တဝိစိတ္တသာရာဘိဝံသ၏ ပရိတ်တရားတော်
 - 7:15 am
 2. တိပိဋကဓရ၊ ဓမ္မဘဏ္ဍာဂါရိက၊ အဂ္ဂမဟာပဏ္ဍိတ၊ ဘဒ္ဒန္တသိရိန္ဒာဘိဝံသ (ယောဆရာတော်) ဟောကြားတော်မူအပ်သော ဥပ္ပါတသန္တိပါဠိတော်
 - 7:25 am
 3. To be healthy exercise
 - 7:30 am
 4. Morning news
 - 7:40 am
 5. Nice and sweet song
 - 7:50 am
 6. အတီးပြိုင်ပွဲ
 - 8:10 am
 7. Musical programme
 - 8:20 am
 8. အရာတော်ရေလှောင်တစ်
 - 8:30 am
 9. International news
 - 8:45 am
 10. Grammar made easy
 - 11:00 am
 1. Martial song
 - 11:15 am
 2. ဝါကျတော်တော်များ
 - 11:30 am
 3. Games for children
 - 12:05 am
 4. Round up of the week's TV local news
 - 12:15 pm
 5. "စက်မှုဖွံ့ဖြိုးတိုးတိုင်းပြည် အကျိုး" (ဖြိုးထွန်း၊ မိုးဒါ၊ စောနိုင်(ရှမ်းပြည်)၊ သဇင်၊ နင်းဆီ၊ ခင်မိုးမိုးအေး) ခါရိုက်တာ-တင်အောင်ရွှေ (သုတေသီ)
 - 12:45 pm
 6. နိုင်ငံစီးပွားအလေးထား ကျေးလက်ထုတ်ကုန်များ (ဈေးနှုန်းမှာချို့ အလှပို ထွက်ကုန်မုဒ်ချည်မျိုးစုံ)
 - 1:05 pm
 7. တံတားအလှပန်းလောင်
 - 1:15 pm
 8. (၂၄)ကြိမ်မြောက် အရှေ့တောင်အာရှ အားကစားပြိုင်ပွဲဝင်မည့် မြန်မာအားကစားအဖွဲ့များ၏ ကြိုတင်ပြင်ဆင်မှုများ (လက်တွေ့)
 - 1:25 pm
 9. Dance of national races
 - 1:40 pm
 10. Musical programme
 - 1:55 pm
 11. အတီးပြိုင်ပွဲ
 - 2:10 pm
 12. ဆင်းရွှေလီစပါး(အပိုင်း-၂)
 - 2:20 pm
 13. အဆိုပြိုင်ပွဲ
 - 2:35 pm
 14. ကွန်ချောင်းရေလှောင်တစ်
 - 2:45 pm
 15. International news
 - 4:00 pm
 1. Martial song
 - 4:15 pm
 2. Song for uphold national spirit
 - 4:30 pm
 3. အေးသင်တက္ကသိုလ် ပညာရေး ရုပ်မြင်သံကြား သင်ခန်းစာ-တတိယနှစ် (ပထဝီဝင်အထူးပြု) (ပထဝီဝင်)
 - 4:45 pm
 4. မြူးမြူးကြွကြွ ယဉ်ကျေးမှုအက
 - 5:55 pm
 5. အတီးပြိုင်ပွဲ
 - 5:05 pm
 6. Musical programme
 - 5:15 pm
 7. မြန်မာလေ့ရိုးရာလက်တွေ့
 - 5:30 pm
 8. ရသပေါ်လွင် သရုပ်ဆောင်လွင်ပြင်
 - 6:00 pm
 9. Evening news
 - 6:30 pm
 10. Weather report
 - 6:35 pm
 11. အလှရှာမယ်လှကမ္ဘာဝယ်
 - 7:00 pm
 12. ကျိုက္ကမီရေလယ်ဘုရား
 - 7:15 pm
 13. နိုင်ငံခြားဇာတ်လမ်းတွဲ "နေပြည်ဆမ်းမှ"
 - 8:00 pm
 14. News
 15. International news
 16. Weather report
 18. နိုင်ငံခြားဇာတ်လမ်းတွဲ "ချစ်စရာပျိုကညာ" (အပိုင်း-၁၅)
 19. The next day's programme

*R 489 Published by the News and Periodicals Enterprise, Ministry of Information, Union of Myanmar. Edited and printed at The New Light of Myanmar Press, No 22/30 Strand Road at 43rd Street, Yangon. Cable Newlight, PO Box No. 43, Telephones: Editors 392308, Manager 392226, Circulation 392304, Advertisement 392223, Accounts 392224, Administration 392225, Production/Press 392369

People's Desire

- ★ **We favour stability.**
- ★ **We favour peace.**
- ★ **We oppose unrest and violence.**

- ★ **RFA, VOA and BBC airing skyful of lies**
- ★ **RFA, VOA and BBC saboteurs, watch your step!**
- ★ **The public be warned of
killers in the air waves —
RFA, VOA and BBC**

- ★ **Skyful liars attempting to destroy nation**
- ★ **BBC lying
VOA deceiving
RFA setting up hostilities**
- ★ **Beware! Don't be bought by those ill-wishers**

Who are the winners, and who, the losers from recent violent protests?

- ★ **Due to the violent protests,**
The people are in a state of panic
Artless persons get into bad company and run into trouble
Trade and commerce hit hard
Vendors and shopkeepers have hard times
Tourism industry in bad shape
- ★ **Due to the violent protests,**
Colonialists' lackey expatriates earn dollars
Touts were provided with funds
Criminals and opportunists are happy with the unrest
National traitors from agitator media gained a lot of dollars